



1 SPORTING REGULATIONS - GENERAL

1.1 TITLE & JURISDICTION

The Ma7da Championship is organised and administered by the 750 Motor Club Ltd in accordance with the National Competition Regulations (NCR's) of Motorsport UK (incorporating the provisions of the International Sporting Code of the FIA) and these Championship Regulations.

- 1) **MOTORSPORT UK Championship Permit No: CH2026/019**
- 2) **MOTORSPORT UK Championship Grade: C**
- 3) **Race Status:** Interclub.

This document defines the specific Championship regulations and structure of the Championship for both fair and safe competition and are to be adhered to by all Entrants and Drivers at all times.

The Organisers reserve the right to amend or clarify these Championship Regulations at any time during the season by way of publication of Official Championship Bulletins issued in accordance with NCR Ch. 3 App. 10 Art 4.2 and subject to Motorsport UK approval.

1.2 OFFICIALS

- 1) **Championship Co-Ordinator:** G. Groombridge, The 750 Motor Club, Donington Park, Castle Donington, Derbyshire, DE74 2BN
☎ 01332 814548; ✉ giles@750mc.co.uk.
- 2) **Championship Eligibility Scrutineer(s):** S. Dockray, Deputy: Bob Blackmore
- 3) **Championship Stewards:**
T. Gregory, C. Emmerson, I. Sowman, T. Stevens

Any three Championship Stewards will constitute a quorum. In the event of any of the Championship Stewards listed above being unavailable or being unable to consider any particular matter due to a perceived conflict of interest, the organisers reserve the right to appoint an alternative Championship Steward or, if deemed to be necessary, more than one alternative Championship Steward.
NCR Ch.4 App.1 Art.1.2. The Championship Stewards can only adjudicate upon any disputes irregularities or appeals arising from the published Championship Regulations. They are also empowered to consider any request from the Championship Coordinator to penalise any Competitor for any breach of Championship Regulations and after holding a formal hearing those Stewards may impose a penalty in accordance with NCR Chapter 2 subject to the rights of Appeal to the National Court.

1.3 COMPETITOR ELIGIBILITY

- 1) Entrants must:
 - a) be fully paid-up valid members of the 750 Motor Club and
 - b) be Registered for the Championship and
 - c) be in possession of a valid MOTORSPORT UK Entrants Licences.
- 2) Drivers and Entrant/Drivers must:
 - a) Be current Members of the 750 Motor Club and
 - b) be Registered for the Championship and
 - c) be in possession of valid Competition (Racing) Club Licence, as a minimum
 - d) Or be in possession of the highest grade of national Race licence or valid FIA International Licence including confirmation of a valid medical certification, together with their ASN's written consent (Motorsport UK National Competition Rules (NCR) Ch.6 App.3 Art.1 and FIA ISC Article 2.3.7.b applies)
 - e) If participation in the Championship requires absence from education a driver, in full time school education is required to have the approval of their head teacher and a letter stating such approval from their school in order to fulfil registration for the Championship. A driver shall not take time out of their education to participate in motor sport without the prior written approval of their education establishment.
- 3) All necessary documentation must be presented for checking at all rounds when signing-on. All competitors must sign-on at Events that they compete in and all necessary documentation must be available to be presented for checking at all times upon the demand of the Officials.



1.4 REGISTRATION

- 1) All competitors must register for the championship by returning the Registration Form with the Registration Fee to the Coordinator prior to the Final Closing date for the first round being entered.
- 2) The Registration Fee for the season is ~~£145~~ £150 payable upon registration. For competitors wishing to enter a single event a registration fee of £35 is payable and points will be awarded for this event. If further races are entered the balance of the ~~£145~~ £150 fee must be paid.
- 3) Registration numbers will be the permanent Competition number for the Championship.

1.5 CHAMPIONSHIP ROUNDS

The Ma7da Championship will be contested over the following rounds*:

Date	Circuit	Round/s
11 April	Croft	2
23/24 May	Pembrey	3
18/19 July	Cadwell Park	3
8 August	Brands Hatch	2
30/31 August	Snetterton 300	2
18 October	Donington Park	2

* subject to valid track licences being in place

If a minimum of 16 entries is not reached by close of entries, the Organisers reserve the right to amalgamate races/classes or cancel races.

1.6 SCORING

- 1) Points will be awarded to Competitors listed as classified finishers in the Final Results as follows:-
35; 32; 30; 28; 26; 24; 22; 21; 20; 19; 18; 17; 16; 15; 14; 13; 12; 11; 10; 9; 8; 7; 6; 5; 4; 3.
All other finishers 2.
All starters who fail to finish 1.
1 point for fastest lap.
- 2) The totals from all qualifying rounds run (excluding any races which are abandoned, and which are not replaced) less 2 will determine the final championship points positions.
- 3) Ties shall be resolved using the formula in the current Motorsport UK NCR Ch.4 App.3 Art.4.
- 4) Where the race distance has been reduced (2.6.) it shall still count as a full points scoring round.
- 5) Competitors not registered for the Championship may be permitted on an individual round basis and will:
 - a) be deemed "Guest Competitors"
 - b) not score points and for the purpose of points scoring will be ignored
 - c) qualify for Event awards
 - d) comply with the eligibility criteria as prescribed in Article 1.3. above, with the exception of 1.3.1. (b) and 1.3.2. (b), as appropriate
- ~~6) Where two drivers are registered in the Team Challenge and are sharing a car, their points scored (as per 1.6.1) will be combined and they will compete for the Team Challenge Awards as per 1.7.3. Each driver must contribute at least 4 scores to the team total.~~

1.7 AWARDS

- 1) All awards are to be provided by the Organising Club unless agreed otherwise.
- 2) Per Round: Trophies to 1st, 2nd and 3rd.
- 3) Championship: Trophies, subject to a minimum of 5 race starts, to:-
1st, 2nd, 3rd, 4th, 5th & 6th overall.
Best Prepared car.
~~Team Challenge trophy for the team with the highest scores as described in 1.6.6.~~
- 4) Presentations: Awards will be presented at the end of each event.
- 5) Entertainment Tax Liability: {deleted}



- 6) If Provisional Results or Championship Tables are revised after any presentations and these revisions affect the distribution of awards the Competitors concerned must return them to the organisers in good condition within 7 days.

2 CHAMPIONSHIP EVENTS & RACE PROCEDURES

1 ENTRIES

- 1) Competitors are responsible for sending in correct and complete entries with the correct entry fee prior to the closing date for entries before each event.
- 2) Incorrect or incomplete entries (Including Driver to be Nominated Entries) are to be held in abeyance until they are complete and correct and the date of receipt for acceptance of entry purposes shall be the date on which the Event Organiser receives the missing or corrected information or fee.
- 3) Any withdrawal of Entry or Driver/Car changes made after acceptance of any entry must be notified to the Event Organisers in writing. Motorsport UK NCR Ch.3 App.11 Art.1.1 applies.
- 4) The Entry Fee for each event shall be specified in the SRs and on the entry form.
- 5) Reserves will be listed in the Final List of Entries published with Final Instructions or in a Bulletin.

2 BRIEFINGS

Organisers will notify Competitors of the times and locations for all briefings in the Final Instructions for the Events. Competitors must attend all briefings. Any Written briefing is an Official Document.

3 QUALIFICATION PRACTICE

- 1) Should any Practice session be disrupted the Clerk of the Course shall not be obliged to resume or re-run the session; the decision of the Clerk of the Course shall be final.
- 2) Each driver shall must complete a minimum of 3 laps in the car to be raced, and in the correct session, in order to qualify (MOTORSPORT UK NCR Ch.12 App.6 Art.3.1).
- 3) At Double Header Race Events, the grid for the second race will be set from the second fastest practice times.

4 RACES

Should any race be disrupted the Clerk of the Course shall not be obliged to resume or rerun the race ((Motorsport UK NCR Ch.12 App.6 Art.9 (1.6.4. above applies).

5 STARTS

- 1) All cars will be released to form up on the grid prior to the start in formation as specified on the grid sheet.
- 2) The start will be via Standing start. The minimum Countdown procedures/audible warnings sequence shall be:-
 - i) 1 minute to start of Green Flag Lap - Start Engines/Clear Grid.
 - ii) 30 Seconds - Visible and audible warning for start of Green Flag Lap.
 - iii) A five second board will be used to indicate that the grid is complete.
 - iv) The red lights will be switched on five seconds after the board is withdrawn and will be switched off to indicate the start of the race
- 3) Any car removed from the grid after the 1-minute stage or driven into the pits on the Green Flag lap shall be held in the pitlane and may start the race after the last car has passed the startline or pitlane exit, whichever is the later to take the start from the grid.
- 4) Any driver unable to start the Green Flag/Pace lap or start are required to indicate their situation as per Motorsport UK NCR Ch.12 App.6 Art.6.11. In addition, any driver unable to maintain grid positions on the Green Flag Lap, to the extent that ALL other cars are ahead of them, may complete the Green Flag lap but MUST remain at the rear of the last row of the grid but ahead of any cars to be started with a time delay.
- 5) In the event of any starting lights failure the Starter will revert to use of the National Flag.

6 SESSION RED FLAG



Should the need arise to stop any race or practice; RED LIGHTS will be switched on at the Startline and RED Light panels / FLAGS will be displayed at the Startline and at all Marshals Signalling Points around the Circuit. This is the signal for all drivers to cease circulating at racing speeds, to slow to a safe and reasonable pace and to return to the pit lane, **during practice**, and to the starting grid area, **during a race**, unless otherwise directed by officials. Cars may not enter the Pits unless directed to do so. Work on cars already in the Pits must cease when a race is stopped. Marshals should revert to displaying yellow flags to indicate to Drivers the particular location of any incident hence supplementing the Light Panels

7 PITS, PADDOCK & PITLANE SAFETY

- 1) **Pits & Paddock:** Competitors must ensure that the MOTORSPORT UK, Circuit Management and Organising Club Safety Regulations are complied with at all times.
- 2) **Pitlane:** The outer lane or lanes are to be kept unobstructed to allow safe passage of cars at all times. The onus shall be on all Drivers to take all due care and respect the pit lane speed limits.
- 3) **Refuelling:** May only be carried out in accordance with the MOTORSPORT UK NCR, the Organising Club Regulations, Circuit Management Regulations and the SRs or Final Instructions issued for each Circuit/Event.
- 4) **Speed Limit:** Pit Lane Speed Limit will be 60 km/h unless otherwise stated by the circuit or as notified in the Final Instructions for the Event/Event.

8 RACE FINISHES

After taking the Chequered Flag drivers are required to:

- 1) progressively and safely slow down,
- 2) remain behind any competitors ahead of them,
- 3) return to the Pit Lane Entrance/Paddock Entrance as instructed,
- 4) comply with any directions given by Marshals or Officials,
- 5) keep their helmets on and harnesses done up while on the circuit or in the pitlane.

9 RESULTS

All Practice Timesheets, Grids, Race Results are to be deemed Provisional until all vehicles are released by Scrutineers after Post Practice/Race Scrutineering and/or after completion of any Judicial or Technical Procedures. Motorsport UK NCR Ch.3 App.6 Art.1.4.

10 TIMING MODULES

The 750 Motor Club utilises AMB transponder-based timing and competitors must have a compatible transponder fitted and working and advise the race organisers of its number prior to the event. The transponder is a TRANX 260 or MyLaps X2 or TR2.

11 QUALIFICATION RACES

If any event is oversubscribed the Organising Club may at their discretion run Qualification Races.

12 OPERATION OF SAFETY CAR

The Safety Car will be brought into operation and run in accordance with Motorsport UK NCR Ch.12 App.8 Art.2.

13 ONBOARD CAMERAS

All competitors are required to carry an on board, in car camera that records to an SD (or micro-SD) card that must be capable of recording HD footage that can be played back on a standard laptop. Recordings from the cameras may be used where there is an incident which is subsequently brought before the Clerk of the Course for investigation.

It is the competitor's sole responsibility to ensure safe installation and effective operation of the camera equipment. At all times cameras must be fitted in accordance with MOTORSPORT UK NCR and be approved by the Chief Scrutineer in accordance with Motorsport UK NCR Ch.7 App.9.



Cameras must be mounted in a position such that the steering wheel and track in clear view. The unit must always be switched on and be recording when the car is on track during any official free practice, qualification session and race.

The onus is on the competitor to ensure that the camera unit battery is charged, the camera switched on to record and ensure the SD card has enough capacity to record the above-mentioned sessions. The SD card must ONLY contain the files from the event in question. The penalties below will also apply.

In the event that no recording is available when requested by the Organisers or Clerk of the Course for judicial purposes then warnings will be issued by the Clerk of the Course for the 1st and 2nd offences which will as a consequence incur the following championship penalties. then the following penalties will be applied by the Clerk of the Course.

- a. First offence – ~~Championship Reprimand~~ **Two Championship Points Deducted**
- b. Second Offence – **Four Championship Points Deducted** – ~~Equivalent to a 5th an 8th place finish.~~
- c. Third Offence – Disqualification from the race or practice session.

3 SPECIFIC CHAMPIONSHIP REGULATIONS

- 1) By registering for the Championship all competitors and their associates commit to positively promote and demonstrate the Motorsport UK's Respect Code which is. is appended to these regulations (Appendix 1).

Where any reports of disrespectful conduct are judged to be well founded the Championship organisers may issue warnings or require remedial actions and/or report the matter to the Championship Stewards who may impose appropriate penalties which can include loss of Championship points and/or race bans through to Championship Expulsion and referral to Motorsport UK.

It is imperative that we promote the safety and wellbeing of young people and adults at risk. In addition to this all participants must be aware of their behaviour and conduct at all times and abusive language and harmful behaviour will not be tolerated. Any such incidents must be reported to the Championship Coordinator and/or Safeguarding Officer who will also relay the report Motorsport UK. Details of the Motorsport UK Policies and Guidelines are available at www.motorsportuk.org/resource-centre by selecting Policies and Guidelines.

- 2) In the event of any rounds being oversubscribed the Organising Club may, in liaison with the Championship Coordinator, at their discretion run Qualification races as per 2.11 of these regulations. Alternatively, at double header race Events, should there be sufficient space within the timetable, the Organising Club may divide the grid after qualifying into 3 separate Groups. The Groups will then form 3 races whereby each competitor participates in two races. All 3 races will be eligible for full championship points.

At each round of the championship, Race 1 grid positions will be determined by each competitor fastest lap time in Qualifying. At double header Events, the grid positions for Race 2 will be determined by second fastest qualifying times.

- 3) The Championship co-ordinator reserves the right to request the fitting of a 750MC owned data logging system to any car prior to competition, and the right to run the car on the Club's rolling road at any time. Failure to comply will result in disqualification.

4 SPECIFIC CHAMPIONSHIP PENALTIES

In accordance with the current Motorsport UK NCR Chapter 2.

4.1 INFRINGEMENT OF TECHNICAL REGULATIONS

- 1) Arising from post practice Scrutineering or Judicial Action: Minimum Penalty:



- The provisions of MOTORSPORT UK NCR Ch.2 App.8.
- 2) Arising from post-race Scrutineering or Judicial Action: Minimum Penalty:
The provisions of MOTORSPORT UK NCR Ch.2 App.8.
 - 3) For infringements deemed to be of a more serious nature the Clerk of the Course will invoke the provisions of MOTORSPORT UK NCR Ch.2 App.8 Art.2

4.2 ADDITIONAL SPECIFIC CHAMPIONSHIP/SERIES REGULATIONS

~~In the case of a driver being disqualified from a race, the Clerk of Course will impose the penalties set out in MOTORSPORT UK NCR Ch.2 App.8 and may impose the penalty set out in MOTORSPORT UK NCR Ch.2 App.8 Art.2.~~

- 1) In order to maintain standards of conduct, the Championship Organisers will monitor all Officials/Observers reports of adverse behaviour at race Events. If any individual is included on two such reports during one racing season the Championship Organisers will request the Clerk of Course at future race Events to consider specific observation of that driver's conduct.
- 2) The Clerk of Course may impose a "Stop-Go" or "Drive through" penalty during a race in accordance with MOTORSPORT UK NCR Ch.12 App.10 Art.2.
- 3) Any Competitor who is penalised under the Championship Sporting Regulations at any stage of a Championship event and receives an allocation of penalty points on their race license in accordance with MOTORSPORT UK NCR will receive a Championship points deduction equal to the number of penalty points which were allocated. Should the same competitor receive penalty points at another round of the Championship then the number of Championship points deducted will be double the number of penalty points applied. If penalty points are applied at a third round, then the Championship points deducted will be triple this number, and quadrupled at the fourth occurrence of such a penalty etc. This may result in a driver receiving a negative score.
- 4) Championship Stewards are also empowered to consider any request from the Championship co-ordinator to penalise any Competitor for any breach of Championship regulations and, after holding a formal hearing if they deem it necessary, to impose a penalty in accordance with MOTORSPORT UK NCR Ch.2 App.2 Art.4 (subject to the rights of appeal provided for in MOTORSPORT UK NCR Ch.2 App.5 Art.1)
- 5) One or more of the following may be imposed by the Championship Stewards as appropriate.
 - a) Reprimand
 - b) Fine. This may be also applied in the case of a driver receiving three reprimands from the Championship Stewards in one season.
~~Time or Grid Penalties~~
 - c) ~~Suspension from all or part of the Championship. This may also be applied in the case of a driver receiving two fines from the Championship Stewards in one season. Disqualification from further participation in the Championship, NCR Ch.2 App.2 Art 4.1~~

5 TECHNICAL REGULATIONS

5.1 INTRODUCTION

- 1) The following Technical Regulations are set out in accordance with the MOTORSPORT UK specified format and it should be clearly understood that if the following texts do not clearly specify that you can do it, you must work on the principle that you cannot. The fact that some modifications are mentioned as prohibited does not imply that others are allowed. The Ma7da Championship is not a Development Formula.
- 2) **STANDARD:** The word 'standard' used within these technical regulations as a description of components is to be interpreted as per 'Standard Part' defined in Motorsport UK NCR Ch.1 App.1. Checking will be by comparison to spare parts supplied by the manufacturer's official agent or by any other means necessary to ensure compliance.



- 3) **STANDARD PATTERN:** The phrase 'standard pattern' used within these technical regulations as a description of components is to be interpreted as per 'Standard Part' defined in Motorsport UK NCR Ch.1 App.1- Checking will be by comparison to spare parts supplied by the manufacturer's official agent or by any other means necessary to ensure compliance.

5.2 GENERAL DESCRIPTION

The **MA7DA CHAMPIONSHIP** is for Competitors participating in cars built to these regulations and the chassis specifications outlined in the book "Build Your Own Sports Car" written by Ron Champion. All cars will run in one class.

5.3 SAFETY REQUIREMENTS

All cars and competitors must comply with the technical and safety regulations listed in the Motorsport UK NCR Ch.7 Competitor Vehicles and Vehicle Safety Equipment, Ch.9 Competitor Personal Safety Equipment (PPE) and Chapter 12 Race.

Rollcage:

A six-point cage as per Diagram 1 in appendix 6 of these regulations, with reference to Motorsport UK NCR Ch.7 App.3 Art.20 is compulsory.

Optional reinforcing members such as those detailed in MOTORSPORT UK NCR Ch.7 App.13 Diagram 21 may be fitted but none may extend forward of the front roll hoop.

A diagonal brace/s within the top of the rollcage as per Motorsport UK NCR Ch.7 App.13 Diagram 19 is recommended.

Side-intrusion bars are strongly recommended to be fitted external to the chassis but may not extend further forward than the front of the driver footwell; they should be constructed using tubes of the same material and dimensions as the main cage and should be fitted by a roll cage manufacturer. Particular care should be taken in selecting the mounting positions for the 'feet' of the cage, with reference to MOTORSPORT UK NCR Ch.7 App.13 Diagrams 22-29 inclusive.

It is important that the roll cage is attached to the vehicle in such a way as to distribute the forces over the largest possible surface.

It is not sufficient to attach the cage to a tube which is not supported vertically. Cages should be designed to form extensions to the chassis itself and not merely as attached components.

Extinguishers must comply with MOTORSPORT UK NCR Ch.7 App.6 Art.1.

Seat belts must be FIA homologated and as per Motorsport UK NCR Ch.7 App.7 Art.7, 8 or 9.

Arm restraints are recommended.

Further reference should be made to:

Ch.7 App.2 General Technical Regulations

Ch.7 App.4 Fuel Systems

Ch.7 App.5 Electrical Systems

Ch.7 App.7 Seats Harnesses and Headrests;

Ch.9 Competitor Personal Safety Equipment (PPE)

Cars with cages that do not comply with the technical regulations listed in the current MOTORSPORT UK NCR Ch.7 App.3 and Ch.12 App.13 Art.11 must be in possession of a valid ROPS certificate and display the manufacturers identification.



5.4 GENERAL TECHNICAL REQUIREMENTS & EXCEPTIONS

All cars must comply with the requirements of the current Motorsport UK NCR Ch.7 Competitor Vehicles and Vehicle Safety Equipment, Ch.9 Competitor Personal Safety Equipment (PPE) and Chapter 12 Race.

All vehicles must comply with MOT requirements (with the exception of front headlights, front & rear side lights and front & rear indicators, rear reflectors, horn, emissions & rear fog light), be of sound construction and mechanical condition and be well maintained.

Cars must be presented to a high standard. Unrepaired damage or cars not achieving a satisfactory level of preparation as judged by the Championship scrutineers may receive a warning and may ultimately result in disqualification.

Presentation of a vehicle for scrutineering is a declaration by the entrant/driver that the vehicle is eligible for that event and fully complies with the Championship regulations. There is no requirement for an MOT Certificate, Road Tax or Insurance.

As a minimum, two mirrors must be fitted, each with a minimum surface area of 50 sq. cm and giving a clear view to the rear, one on each side of the centreline of the vehicle.

5.5 CHASSIS

Chassis must remain identical to original in terms of material construction and dimensions. However, it is permitted to add an engine bay diagonal (line A) to mirror that on the driver's side and two bracing bars (lines B & C) between the cockpit sides and the junction of the dashboard top/transmission tunnel as per the drawings in Appendix 6 of these regulations.

A permitted alternative rear bulkhead drawing is also shown in Appendix 6.

It is also permitted to add a transverse bracing tube to the lower chassis in the footwell area as per the drawings in Appendix 6. The fitment of optional brace bars A, B & C are highly recommended. **It is also permitted to retain chassis members C & B1 uncut as per the drawings in Appendix 6.**

Towing Eyes with a minimum internal diameter of 60mm, as detailed in Motorsport UK NCR Ch.12 App.13 Art.1.3 & 1.4 must be fitted, front & rear, no higher than 18" from ground level; any metal portion of the towing eyes must be within the overall periphery of the vehicle and may be extended by means of a suitable flexible strap.

A propshaft restraint must be fitted in accordance with MOTORSPORT UK NCR Ch.7 App.2 16.

The area below the cockpit must have a steel floor of at least 18swg/1.2mm which must be substantially welded to the chassis as per Diagram 6 in the Appendix to these regulations. Aluminium under-skinning of the area behind the cockpit is permitted within the plan profile of the chassis and may not be extended beyond that profile.

There must be drainage holes to prevent the accumulation of liquids.

No edges of any part of any under-skinning may extend downwards beyond the silhouette of the chassis.

It is permitted to strengthen the steering rack mounts. It is recommended that all tube ends are sealed to prevent corrosion.

MATERIALS: Minimum thickness of:- chassis tubing = 16swg/1.5mm; steel floor = 18swg/1.2mm; aluminium panelling = 18swg/1.2mm. It is permitted to panel the transmission tunnel in 16/18swg aluminium as an alternative to steel. Spacing of rivets is free.

5.5.1 MODIFICATIONS PERMITTED



Bottom chassis member “C” in Diagram 6 (see appendix) may be removed and may be reinstated via a bolt on brace or chassis member.

The top horizontal section of transmission tunnel directly above chassis member “B2” in Diagram 6 (see appendix) may be relocated towards the front of the vehicle by up to 80mm in order to allow for gear linkage clearance.

A gearbox mount with a maximum area of 100cm² may be welded or bolted to the chassis where appropriate. It is strongly recommended that Mazda engines are offset to fit if necessary, around all existing chassis members within the engine bay.

Driver's side reinforcement bar ‘R’ may be moved outboard (at bulkhead end) by 25mm (additional to the dimension given in Diagram 6) for clearance purposes, however competitors should ensure that the transmission tunnel remains in line with ‘R’. This may be either by widening the tunnel or via a suitable welded rearward brace/gusset alongside ‘n’ so as to meet ‘R’.

An alternative plate or box section arrangement may be used instead of the two box sections that rise vertically from chassis member B2 solely in order to increase gearbox clearance, or the tunnel may be widened by 25mm to suit.

Competitors should ensure that any of the above chassis’ modifications are suitably designed and executed so as to meet or exceed the strength of the original structure.

5.5.2 MODIFICATIONS PROHIBITED

Anything in contravention of 5.5.1

5.6 BODYWORK

Front and Rear Wings Material: Fibreglass traditional style as shown in photo in section 6 of these regulations. Solid Surface with no aerodynamic devices either attached or moulded in.

Rear Panel Material: Aluminium or glass fibre with solid surface.

Scuttle Material: Fibreglass, aluminium or steel.

Bonnet Material: Aluminium or fibreglass.

Nose cone Material: Fibreglass.

Side Panels Material: Aluminium. The side panels must be fitted directly on to the chassis top and bottom side rails.

5.6.1 MODIFICATIONS PERMITTED

- 1) **General:** Bodywork must remain unaltered, subject to 5.6.1.4
- 2) **Interior:** Only a fire extinguisher, a battery, Handbrake Lever with Cable(s) or hydraulic lines, additional ballast (retained safely to Motorsport UK NCR Ch.7 minimum fastening) and any rollbar bracing may impinge upon passenger space. There must be a removable panel in the top of the driver's footwell which permits access for inspection of the brake pedal to master cylinder linkage.
- 3) **Exterior:** All parts of the engine and transmission must be fully enclosed within the bodywork. Air filters may only protrude above the main bonnet silhouette line if they are enclosed within a ‘bulge’. Air filters must not protrude outside the contours of a standard ‘Ma7da’ nosecone shape (i.e. raised/bulged Locost nosecone). A forward-facing louvre or opening may be fitted in the nosecone/bonnet/bulge ahead of the air filter but must be covered by a gauze/mesh that follows the contours of the panel or bulge.



Any other holes (except for air filter detailed above) in the upper surface of the bodywork forward of the steering wheel and above a longitudinal line joining the top of the front and rear wheel rims plus any holes in the side surfaces of the bodywork forward of the steering wheel above a longitudinal line joining the top of the front and rear wheel rims, must be covered by solid bodywork having only a forward facing opening, forward facing louvres or with a gauze/mesh with a maximum hole size of 1mm and that follows the contours of the panel. No openings or mesh panels are permitted rear of the front bulkhead.

Vents may be fitted in the side surfaces of the bodywork forward of the engine bay/passenger compartment bulkhead and below a longitudinal line joining the top of the front and rear wheel rims. These vents are restricted to being fitted into an aperture in the bodywork of a maximum surface area of 430sq cm per side. Any vents must have a maximum protrusion of 25mm, rearward facing or covered by gauze.

Holes solely for the exhaust system do not require any cover/gauze but must be a reasonably close fit. All vehicles must be fitted with a windscreen or an aero screen of minimum vertical height, measured at its attachment to the bodywork, of 75mm and a minimum width of 250mm. The passenger space may be covered by a removable tonneau of soft flexible material or fibreglass fitted no higher than the top edge of the bodywork. Fibreglass tonneaus must have a minimum vertical return depth of 40mm on the side adjacent to the driver and be protected with non-flammable padding as per Motorsport UK NCR Ch.12 App.13 Art.2.5.

Fibreglass or flexible material side tonneaus/'half-doors' may be fitted but must not extend vertically above the top of the scuttle panel.

Soft or hard top roofs are not permitted.

A front number plate or a solid mounting plate 525mm wide by 115mm high (± 5 mm on both dimensions) mounted securely and permanently vertical at all times, under the front of the nosecone and complying with ride-height regulations is mandatory.

Competitors will be issued with championship decals to be affixed to the plate.

For clarification of MOTORSPORT UK NCR Ch.7 App.2 Art.6.9. Front mudguards must present no sharp edges and cover the complete wheel (flange, tyre and rim) around a minimum arc of 120° measured from hub centre and must be a continuous surface of rigid material with no gaps holes slots or vents. The front edge of the mudguard must be ahead of the vertical hub centreline. The rear edge of the mudguard may not be more than 50mm above the hub horizontal centreline. See Diagram 7 in Section 6 (The Offside front Mudguard may have a flexible mud flap fitted for the sole purpose of deflecting water.) Rear mudguards must present no sharp edges, cover the complete wheel width (flange, tyre and rim) and must be a continuous surface of rigid material with no gaps holes slots or vents. The complete front and rear edges of the mudguard must be on or below the centreline of the rear wheel, measured with the driver seated in the normal driving position. See Diagram 7 in Section 6

- 4) **Bodywork:** Must remain unaltered 'Locost' "Seven" style bodywork with the exception of height of the scuttle and any "bulge" fitted to the bonnet in order to accommodate the Mazda engine.
- 5) **Ground Clearance:** Under no circumstance can any part of the bodywork/chassis, or of the suspended part of the car with the exception of the exhaust system, the sump, sump guard and the bellhousing, be below a horizontal plane passing 75mm (60mm for the sump, exhaust system and the bellhousing) above the ground, the car being in normal racing trim with the driver aboard. Sump guards may be fitted with a minimum ground clearance of 50mm. The front and side edges must be affixed to the closest chassis members only. The rear edge of the sump guard must be a straight edge in plain view which must sit a minimum of 80mm from the forward-most part of the bellhousing casting, and it must be possible for at least 20mm length of the lowest part of the sump to be checked for height by means of a sliding gauge without the guard being removed. It is permitted to add shims to or modify the engine mountings in order to comply with these minimum heights. There is no minus tolerance to these measurements.



5.6.2 MODIFICATIONS PROHIBITED

- 1) **General:** Kevlar, carbon fibre and titanium materials are not permitted.
- 2) **Interior:** It is not permitted to mount the fuel tank/s within the passenger space.
- 3) **Exterior:** Aerofoils, spoilers and side pods are not permitted. No adjustable aerodynamic devices are permitted. Wheel arch extensions are not permitted. 'Under-skinning' of the chassis is prohibited with the exception of the areas detailed in 5.5
- 4) **Bodywork:** Modifications to the bodywork which the organisers or scrutineers deem may give an aerodynamic advantage are prohibited:
- 5) **Ground Clearance:** Side skirts or bridging devices are not permitted.

5.7 ENGINE

The only permitted engine is the 1.8i VVT Mazda BP-6D (also known by US identification code BP-Z3), produced from 2001 to 2005. Both block and cylinder head must be externally identifiable as BP-6D/BP-Z3 components.

All internal engine parts must be standard or standard pattern parts, it is the competitor's responsibility to ensure that no prohibited modifications have been carried out if they are using an engine not assembled by them. Technical data on specific engine components are contained within the official Mazda workshop manual which can be found at the following link:

https://www.750mc.co.uk/ugc-1/1/1/0/ma7da_engine_workshop_manual.pdf

Cylinder bores must remain standard and the original size with standard sized Mazda OEM pistons (BPZ3-11-SA0). No over boring is permitted even to allow the reclaiming of engines. Oversized Mazda OEM pistons (BPZ3-11-SB0 and BPZ3-11-SBX) are not permitted.

Two adjoining rocker cover bolts and two adjoining sump bolts must be drilled to accept scrutineer's locking wire.

1) Modifications permitted

Cylinder heads must be a minimum of 133.6mm high from machined face to machined face. This allows for reclamation by skimming to a typical maximum of 0.2mm (0.008in). Skimming ('decking') the block is not permitted, and piston protrusion must be as standard.

The only permitted head gasket is a standard OEM Mazda BP6D-10-271 or standard pattern replacement. It is the competitor's responsibility to ensure that any pattern parts have the same compressed height as an OEM Mazda head gasket. The standard throttle body water circuit may be bypassed.

No other modifications are permitted. Replacement of valves, valve guides and valve seats must be with parts of standard pattern and material, and valve seat profiles/angles may not be modified.

2) Modifications Prohibited

Any other than those permitted in 5.7.1. The standard cam belt cover/s must be retained. It is specifically prohibited to modify inlet ports, exhaust ports and combustion chambers in any way, and all must remain as cast. Camshaft profiles and cam timing must remain as standard and the removal or addition of metal by grinding, or modification is prohibited.

An unmodified OEM or pattern crank sensor must be fitted in the standard Mazda position and orientation with the standard fastener. The crank pulley timing wheel must be unmodified OEM and fitted in the original location and orientation. Upper, middle and lower cambelt covers must all be fitted in respective standard locations but may be replaced with unmodified standard pattern parts. Sumps and respective oil pickups must not be modified or shortened in any way. It is not permitted to modify the OEM Mazda pulleys (including the crank pulley) in any way.



3) **Location**

The engine must be fitted in line with the longitudinal axis of the chassis +/- 3 degrees (both deviation from the longitudinal axis of the car, and rotational deviation from vertical on the axis), with the crankshaft axis within 60mm of the chassis centreline. Horizontal flat plate sections with a thickness up to 5mm and maximum area 100cm² may be bolted or welded to the chassis in order to accommodate mountings.

The rear face of the engine block (where the gearbox mounts) must be a minimum of 13cm from chassis member "Q" in Diagram 3 (see appendix).

4) **Oil/Water cooling:**

Water radiators are free. Oil coolers are not permitted with the exception of the standard Mazda oil cooler fitted to the BP-6D.

5) **Induction Systems:**

An aftermarket cone or cylindrical air filter may be used but it must be open and not enclosed in an airbox of any sort. Heat shielding of the filter is permitted but must not fully enclose the filter.

Cars must use an unmodified "flat top type" inlet manifold assembly from a UK Mazda BP-6D engine. All parts of the assembly that form part of the inlet tract must remain entirely unmodified, with no machining and internal surfaces that remain 'as cast'. All vacuum pipe holes and the EGR valve hole are to be closed off via removeable mechanical means and the OEM lower brace may be removed for chassis clearance. It is permitted to use an alternative inlet manifold support brace: the positioning and design of this is free but it must use existing fasteners or tappings on the inlet manifold assembly.

A standard (59 mm) throttle body assembly from a BP-Z3 or BP-6D engine must be used. It is permitted to re-bush the throttle body spindle pivots with aftermarket brass bushes to OEM dimensions, however no other modifications are permitted.

6) **Exhaust systems:**

The exhaust manifold must be replaced with an unmodified (except as below) GBS Ma7da manifold (see appendix) or JP Exhausts Ma7da manifold supplied by the 750 Motor Club complete with an unmodified 100-cell catalytic converter downstream and ahead of a silencer. It is permitted to weld where the primary exhaust manifold pipes terminate on the inside of the manifold to head flange plate and dress/grind back the added weld if required. Any post-weld grinding must not extend outside the original shape of the port on the GBS flange plate, and no material may be added or removed at a depth greater than 10mm along the primary pipes, measured from the engine side of the flange. For the avoidance of doubt, the primary pipes inside the flange must remain present and complete and may not be dressed back to the downstream side of the flange plate.

It must be possible for the catalytic converter element to be inspected internally at one end via means of a bolted/clamped connection and competitors are encouraged to consult the Ma7da Builders' Guide for guidance on placement and parts. The rest of the exhaust system (including silencer) is free but must terminate on the passenger side of the chassis ahead of the rear wheel. No part of the manifold, silencer, or exhaust pipe may be covered or coated irrespective of any heat-resistant properties. The wide band lambda sensor supplied with the ECU must be present, fitted in the manifold boss and operational at all times.

7) **Ignition systems:**

Cars must use a control Emerald K6+ ECU supplied and sealed by the 750 Motor Club. Competitors may be asked to temporarily swap their ECU for one supplied by the organisers or returned to Emerald for periodic map updates or checks. Failure to comply will result in disqualification. The ECU must be positioned in an easily accessible location under the bonnet or in the cabin. The ECU serial number must be the same as submitted during registration, unless a change to an alternative Ma7da Emerald ECU is notified to 750MC in writing in advance of any session on track.

ECUs must use the 2023 Ma7da Control Map, which is available from 750MC on receipt of a competitor's ECU to the Club office for update. The ECU serial number must be the same as submitted during



registration, unless a change to an alternative Ma7da Emerald ECU (also using the 2023 Ma7da Control Map) is notified to 750MC in writing in advance of any session on track.

The VVT mechanism must remain connected and fully working at all times. Aftermarket controllers, ECUs or any other device with the ability to alter VVT timing are not permitted.

The use of individual coil packs is permitted.

8) **Fuel delivery systems:**

Fuel delivery systems: A low-pressure fuel pump should be fitted together with a high-pressure fuel pump and swirl pot arrangement (or just a high-pressure pump with an in-tank swirl pot), connected to the unmodified BP-6D fuel rail. A non-adjustable fuel pressure regulator must be the final component fitted to the fuel system inline before the fuel rail. Pressure testing may be undertaken to ensure that the fuel pressure does not exceed 3.3bar. All cars must have a **male Aeroquip FD90** dry break take off-port ~~male threaded take-off port with AN-6 fittings,~~ installed between pressure regulator and fuel rail in order to allow for fuel pressure testing equipment to be used.

9) **Lubrication System:**

The standard BP-6D sump, windage tray, oil pump and oil pickup must remain unmodified in terms of construction and assembly, however an aftermarket sump baffle may be used and the addition of shims / washers under the spring in the pressure relief valve may be used in order to maintain correct oil pressure. Sump guards are permitted.

5.8 SUSPENSION

1) **Permitted Modifications:**

The original type of suspension system must be retained and should be: -

Front: Unequal length wishbones with suspension pick-up points to the dimensions in Diagram 3, Appendix 6 of these regulations. The bushes for the inboard end of the wishbone must be either bonded rubber (Metalastic type), or 'plastic' non-metallic.

Springing may be only by coil spring damper units ('coilover dampers') with only one single piece single rate spring per damper. No additional springing medium is permitted. Dampers constructed of steel or alloy (including the mounting eyes) with internal reservoirs may be used and if adjustable, only have a single adjustment. Dampers may use rose or spherical joints at each end. The longitudinal positioning of either the top or bottom front suspension pick-up points on the chassis may be adjusted to provide the correct caster, if required. Also, the wishbone chassis brackets may be wider to allow caster adjustment. The upright and hubs must be from Ford Cortina Mk III, IV or V. An anti-roll bar may be fitted but must be one-piece and use only one link at either end to connect to the suspension. It is permitted to use alloy HiSpec uprights (part number UR101 (LH) & UR102 (RH)) and their respective alloy stub axles (UR100), top & bottom sleeves (UR300) and appropriate steering arms (part number UR103 (LH) & UR104 (RH)) and alloy HiSpec Ford Cortina "NON-Lightweight" hub (part number HB001)

Rear: Escort Mk1 or Mk2 live rear axle located by upper and lower trailing arms each side combined with a 'Panhard' rod. Aftermarket two-piece half shafts may be fitted. The chassis pick up points for the rear radius rods must retain the longitudinal position specified in the book but may be moved vertically to either 4.3" or 5.75" apart; it is recommended that the radius rods should be kept parallel. The bushes for the ends of the trailing arms must be either bonded rubber (Metalastic type) or plastic.

For the Panhard Rod one 'Rose-joint' may be used but only at one end. 'Plastic non-metallic' suspension bushes may be used. The chassis bracket for the panhard rod may have an alternative vertical pick-up point. This is to allow the panhard rod to be parallel with the ground. An anti-roll bar may be fitted but must be one-piece and use only one link at either end to connect to the suspension.

2) **Prohibited Modifications**

No controls which could allow adjustment of anti-roll bars by the driver whilst normally seated are permitted. The use of spherical rod ends and rose joints is prohibited other than for one end of the



'Panhard' Rod, the damper eyelets and the anti-roll bar links. The use of anti-roll bars consisting of more than one torsion element is prohibited. Modifications to suspension pickup points other than those permitted in 5.8.1 are prohibited.

3) **Wheelbase/track**

Wheelbase must be to the original dimensions. The maximum permitted track is 1610mm. This measurement is taken between the outer most point of each tyre at the point where the tyre makes contact with the ground.

5.9 TRANSMISSION

The gearbox must be a manual 5 speed Mazda MX5 unit from any Mk1, M2 or Mk2.5 model, unmodified and with the following ratios.

1st	3.136
2nd	1.888
3rd	1.330
4th	1.000
5th	0.814

A standard or standard pattern Mk2.5 VVT sprung organic friction plate and cover plate must be used. For clarification this means that plates must be of full circumference and paddle clutch plates, and metallic/ceramic/cermetallic compounds are not permitted. Clutch operation may be hydraulic or mechanical. The propshaft must be of steel construction, suitable units are available from GBS (see appendix.) Flywheels must be standard Mazda BPR7-11-500A and weigh a minimum of 7.5kg.

1) **Permitted Modifications**

A 'quick shift' gear linkage may be fitted. The use of foam baffles in the rear axle is permitted.

2) **Prohibited Modifications**

Four-wheel drive is not permitted. Rose joints or spherical rod ends are not permitted in any transmission locating linkages with the exception of that detailed in 5.8.1. Any form of traction control is not permitted.

3) **Final Drive ratios**

The final drive ratio and differential must use genuine series-production FoMoCo parts; optional Ford Motorsport final drive ratios, differential units or specialist competition parts are not permitted. The only permitted final drive ratios are 3.9:1 or 3.89:1 Limited slip, locked, torque-biasing differentials or similar are not permitted. The use of alloy or magnesium differential housings is prohibited.

It is permitted to modify the axle casing externally via the use of a steel reservoir to replace the standard casing 'back plate', shown in red on Diagram 8. This must be symmetrical when viewed from the rear of the car and be welded to the rear of the axle for the sole purpose of increasing oil capacity. The reservoir may be either round with cone tapered sides, or hexagonal or octagonal (when viewed from rear) with angled sides.

The added reservoir is permitted to extend a maximum of 75mm from the rear of the casing (see drawing) and be a maximum size of 215mm vertically and 245mm horizontally at axle casing end & 175mm (vertically & horizontally) at rear end, with angle of taper from the vertical rear face of the axle case being no more than 70 degrees (see drawing). Baffles may be added internally along the axle tubes (either as plates or foam lagging,) for the sole purpose of oil control. These must be fitted in the half shaft tubes only, and not within the diff casing. Filler and drain plugs may be added - type and location are free.

5.10 ELECTRICS

1) **Exterior Lighting:**

Brake warning lights must be operational and operated only by the brake pedal without a delay. Headlights if fitted must be a minimum diameter of 5 3/4". The front headlights may be removed and the,





front and rear side lights and front and rear indicators may be removed as per MOTORSPORT UK NCR Ch.7 App.5 Art.1.2.

Rear Warning Light:

An LED rear fog light to EU regulation 7, an FIA homologated LED rear warning light, or an LED stop light to EU regulation 38 is mandatory and must be mounted directly to the rear or the underside of the rear roll hoop, within 10cms of the centreline of the vehicle. Any manufacturer fitted rear fog light must not be switched on unless it complies fully with this regulation.

2) **Batteries:**

A battery and starter motor capable of repetitive starts must be fitted and operable by the driver whilst normally seated.

3) **Generators:**

A fully working alternator from a Mk1 Mazda MX5 must be fitted (either Mk1 1.8 with multi-rib belt, or Mk1 1.6 with an OEM 1.8 multi-rib pulley fitted). This must be electrically connected so that the standard battery charging function is providing a charge to the onboard battery. The alternator/generator must be located in the standard position. Alternative mounting brackets may be used. Competitors should note that the 'smart' alternator fitted as standard to the BP-6D engine cannot be used and will damage the Emerald ECU if fitted.

5.11 BRAKES

- 1) **Rear brakes** may be either FoMoCo drum brakes from a 'Kent' engined Cortina, Capri or Escort (brake lining material is free). Alternatively, single piece cast iron discs with a maximum diameter of 247mm may be used. Discs may be grooved, vented and cross drilled. Callipers may be either alloy or cast iron but must be either single piston sliding type or with a maximum of two pistons.
- 2) **Front brakes** must be standard Cortina one-piece cast iron discs from a 'Kent' engined Escort, Cortina or Capri with a maximum diameter of 247mm. Discs may be grooved, vented and cross drilled. Callipers must be of cast iron construction from a Ford Cortina however these may be modified in order to accept thicker vented rake discs. Pad material is free, though carbon-fibre is prohibited Brake hoses are free.
- 3) **A handbrake mechanism** must be fitted. It shall operate on both rear wheels and be capable of resisting movement (forwards and backwards) when tested by a Scrutineer on flat level dry surface. This may be either cable operated or work using a hydraulic handbrake assembly acting in the rear brake line.
- 4) **Permitted Modifications:**
The friction face of the brake drum may be reclaimed by simple machining within manufacturer's repair tolerances. Pedal box and master cylinder/s are free. An adjustable bias valve may be fitted.
- 5) **Prohibited Modifications:**
ABS systems are prohibited. The use of brake drums which are modified in any way other than that permitted in 5.11.1 is prohibited.

5.12 WHEELS / STEERING

- 1) **Permitted Options:**
Steering rack must be standard or standard pattern Ford Escort Mk1 or Mk2 fitment; the ratio of the rack is free. Steering rack mounts may be strengthened and rubber bushes replaced with different materials.

Steering arm extensions are not permitted.
- 2) **Prohibited Options.**
No other modifications are permitted including the fitment of any 'wheel trims' or similar air deflectors.
- 3) **Construction & Materials:**
WHEELS: Steel or one-piece aluminium-alloy.



- 4) **Dimensions:**
Maximum width 6". Diameter 13".

5.13 TYRES

1) **Specifications:**

The only permitted tyres are the Toyo R888R (GG Compound) sized at 185/60/R13. No alteration to the tyre from the manufacturer's specification is permitted. Re-cutting, re-grooving or in any other way modifying the tread pattern is not permitted. All the manufacturer's data must be clearly visible. Buffing of sidewalls to remove data is prohibited. The use of tyre heating/heat retention devices, tyre treatments and compounds is prohibited.

2) **Nominated Supplier:**

SCP Tyres

www.scptyres.co.uk

Email: steve@scptyres.co.uk

Tel: 07860 471256

3) **Number of Tyres:**

Toyo R888R tyres must be barcoded (see example below). Tyres must be purchased through SCP Tyres and will be automatically barcoded, for any tyres purchased prior to the start of the 2024 season barcodes will be available from SCP Tyres at additional cost.

Drivers will only be permitted to use a total of 12 44 Toyo R888R tyres during the course of the season.

Drivers will be required to nominate which tyres they are using at each race weekend when they present the car at scrutineering, this will be done via a tyre information form listing the barcode identification numbers of the driver's chosen tyres. Any competitor found during post qualifying/race scrutineering, to have qualified or raced with a tyre not listed on the 'Tyre Record Form' or to have exceeded their allotted number of tyres for the year will be disqualified from the results and may be subject to further penalties.

Tyres are not transferable between drivers.

An example bar code is shown below:



5.14 VEHICLE WEIGHT

Minimum weight including driver and race overalls, helmet etc. is 665kg.

5.15 FUEL TANK / FUEL

1) **Types:**

Fuel tanks are free, but safety tanks are recommended. A non-return valve must be incorporated in the vent system.

2) **Locations:**

Free within the area behind the rear bulkhead. Chassis or bulkhead may not be modified to allow fitment of the tank (it is recommended fuel tanks are not mounted directly to the aluminium rear bulkhead panel as this may contravene Motorsport UK NCR Ch.12 App.13 Art.1.

The exception to this is to allow the addition of brackets to the chassis for the mounting of the fuel tank.



On safety grounds none of the fuel filler pipework, the filler cap or associated fittings may be attached to the external bodywork.

3) **Fuel:**

Only petrol as defined in NCR Ch.8 App.1 Art.1.7a and complying with BS4040, BSEN228 or BS7800 may be used; fuel which exceeds the stated RON (max) levels in NCR Ch.8 App.1 Art.1.7a is prohibited even if it is sold/promoted as being legal for UK Competition and/or obtainable from 'roadside' pumps. The use of additives by competitors which boost the octane rating (RON) in any petrol is prohibited. At the end of practice and the race at least 3 litres of petrol from the tank of the competing car must be available to the scrutineers for analysis. Compliance with minimum weight for the car will be taken before the petrol is removed

5.16 SILENCING

All vehicles must comply with the relevant maximum noise limits set out in Motorsport UK NCR Ch.7 App.13 Chart 1 Maximum noise limits-

5.17 NUMBERS AND SERIES/CHAMPIONSHIP DECALS

- 1) **Positions:** Race numbers must be displayed on each side of the vehicle alongside the cockpit/driver and as far forward on the front of the vehicle as possible. 750 Motor Club decals must be affixed prominently on each side of the car and dashboard. Championship Sponsor's decals (where applicable) must be affixed in or near the positions detailed on any diagram supplied with those decals. No decals may be affixed to the aeroscreen. 750 Motor Club and Championship Sponsor's decals must take preference to any other decals. Failure to comply will render the vehicle and driver ineligible to race.
- 2) **Suppliers:** Sponsors and Club decals will be available at the first Championship race in which the vehicle is entered.

APPENDICES

Diagram 1 – ROPS guidance notes if no ROPS certificate exists for a given cage design.

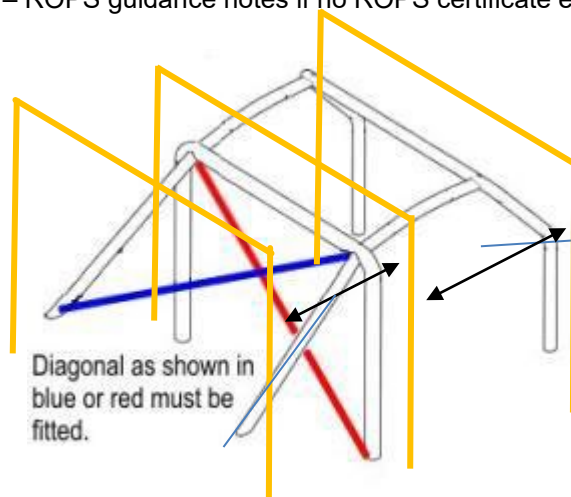

Diagonal as shown in blue or red must be fitted.

Front section of Roll cage not covered by ROPS but is a mandatory requirement for class regulations.
Tube sizes (Including side impact bar(s)) to be diameter 38mm x 2.5 (1.5" x 0.095") or 40mm x 2.0 (1.6" x 0.083") or larger.
(See MOTORSPORT UK National Competition Rules (NCR) Ch.7 for Material specification and further details)

Note:- For any MOTORSPORT UK ROPS Certified systems please ensure Valid Certification for the class ('Locost') and Certificate label attached in correct position as defined by the ROP's Certification documentation.

Rear section of Roll cage must meet MOTORSPORT UK Regulations (See NCR Ch.7)
Tube to be diameter 45mm x 2.5 (1.75" x 0.095") or 50mm x 2.0 (2.0" x 0.083")
Rear stays at 30 degrees to the vertical, with steel reinforcement plate at least 3mm thick and of at least 120cm² area at the point of attachment to the chassis.
(See MOTORSPORT UK National Competition Rules (NCR) Ch.7 for Material specification and further details)

Contact 750MC Chief Scrutineer for any clarification or MOTORSPORT UK

Diagram 4

Top drawing is Front chassis frame and location of the suspension mounting brackets (As standard).
 Alternative dimensions for the suspension mounting brackets may be used but must conform to the dimensions shown in the lower diagram.
 (Tolerance $\pm 15\text{mm}$ unless otherwise stated on drawings)

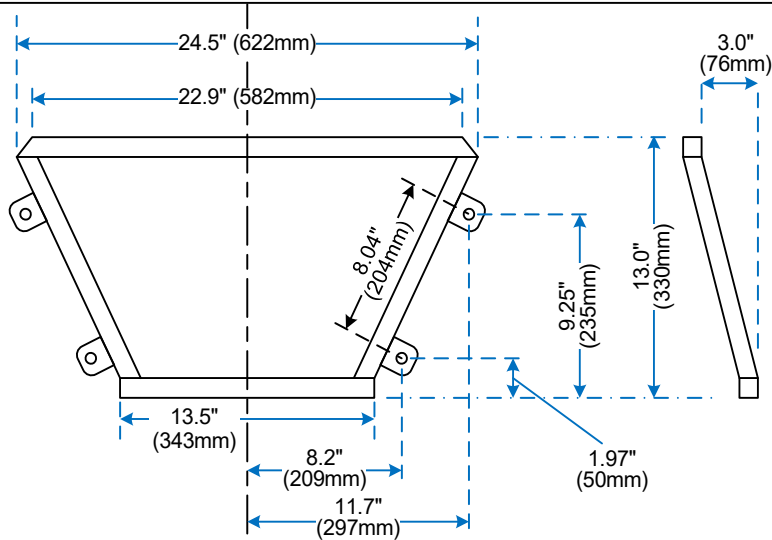

A: Inner lower pickup to underside of Chassis 65mm $\pm 20\text{mm}$
 B: Inner upper pickup to underside of Chassis 245mm $\pm 20\text{mm}$
 Distance between:-
 C: Inner lower pickups 420mm $\pm 40\text{mm}$
 D: Inner upper pickups 600mm $\pm 40\text{mm}$

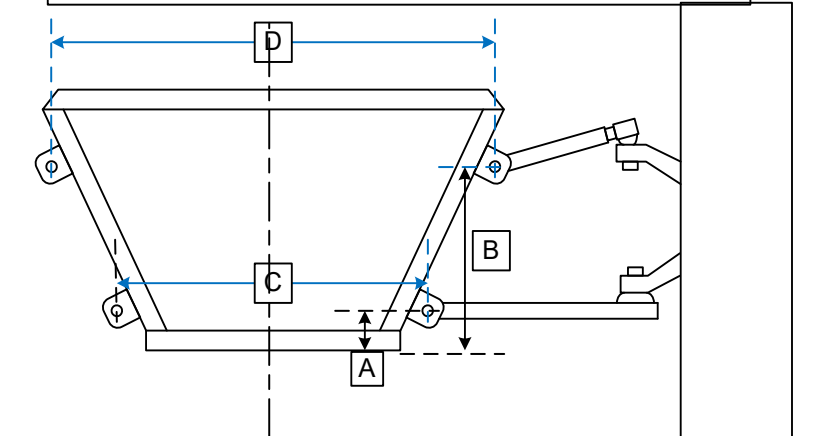

Diagram 5

Position of rear suspension mounting brackets
(Positioning tolerance +/- 5mm)

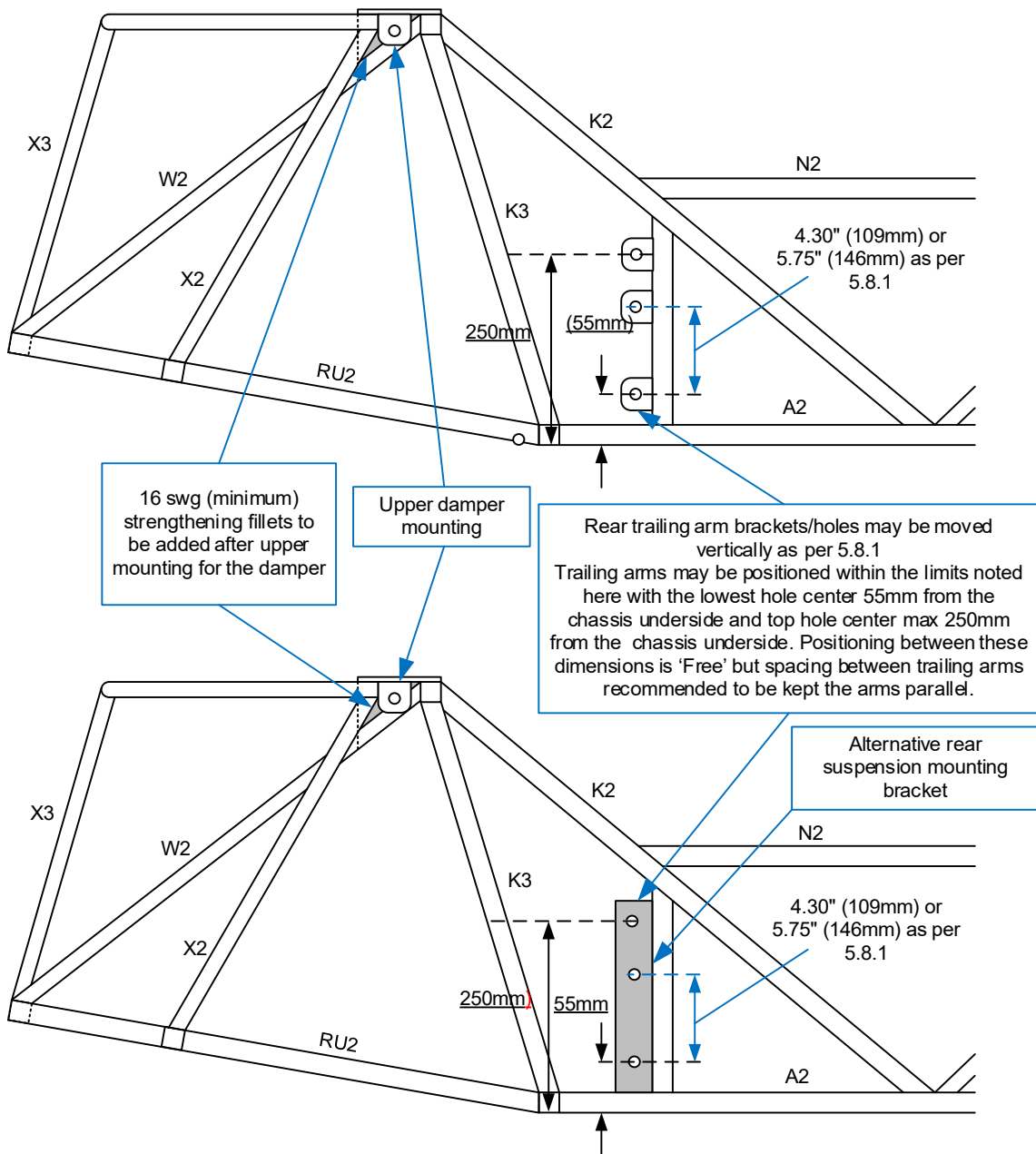
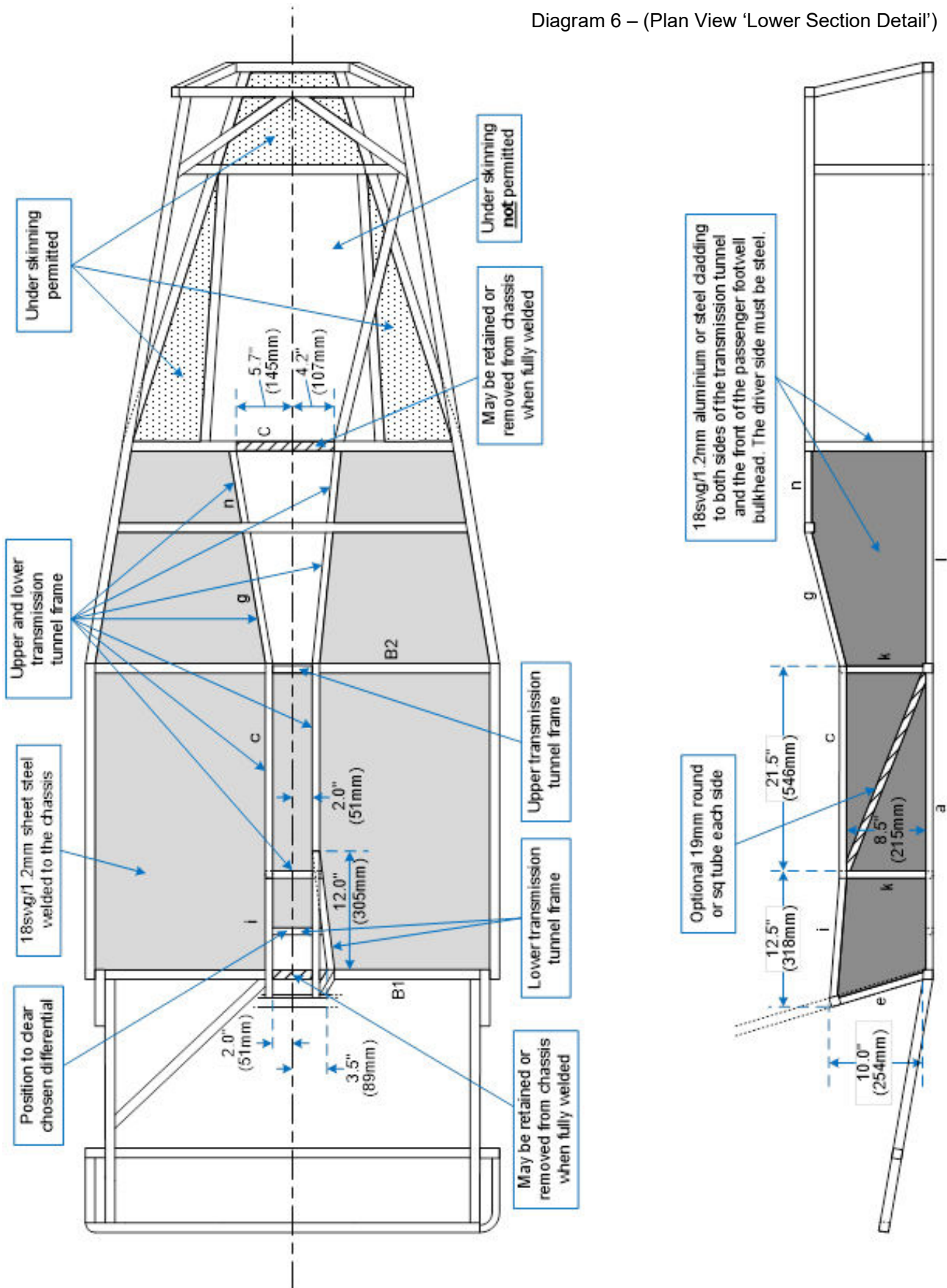

Diagram 6 – (Plan View ‘Lower Section Detail’)



(Diagram 7) Front and Rear Mudguards – Example types and position diagrams.



Rear Mudguard side view – Offside (Nearside is mirror view)

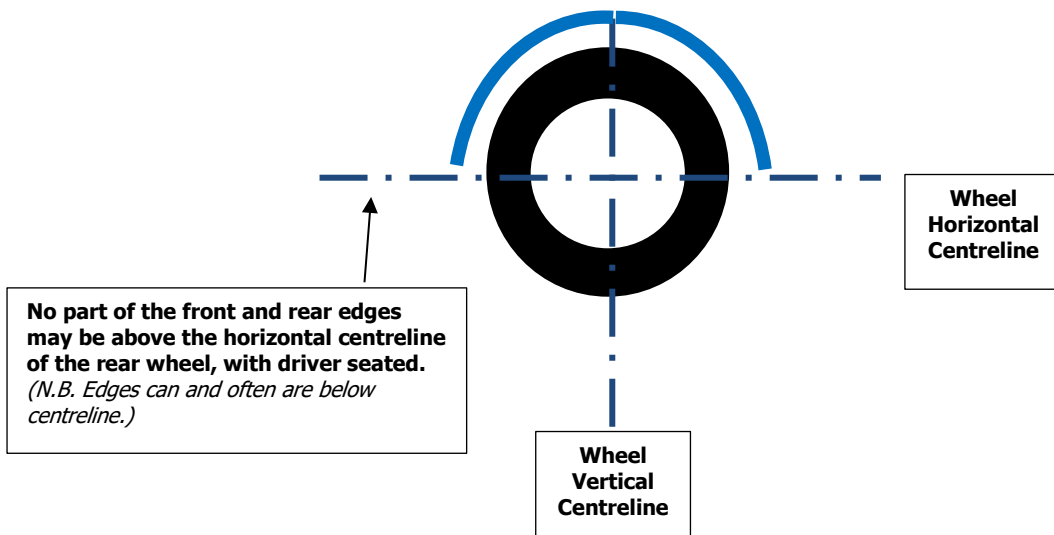

Front Mudguard side view – Offside (Nearside is mirror view)

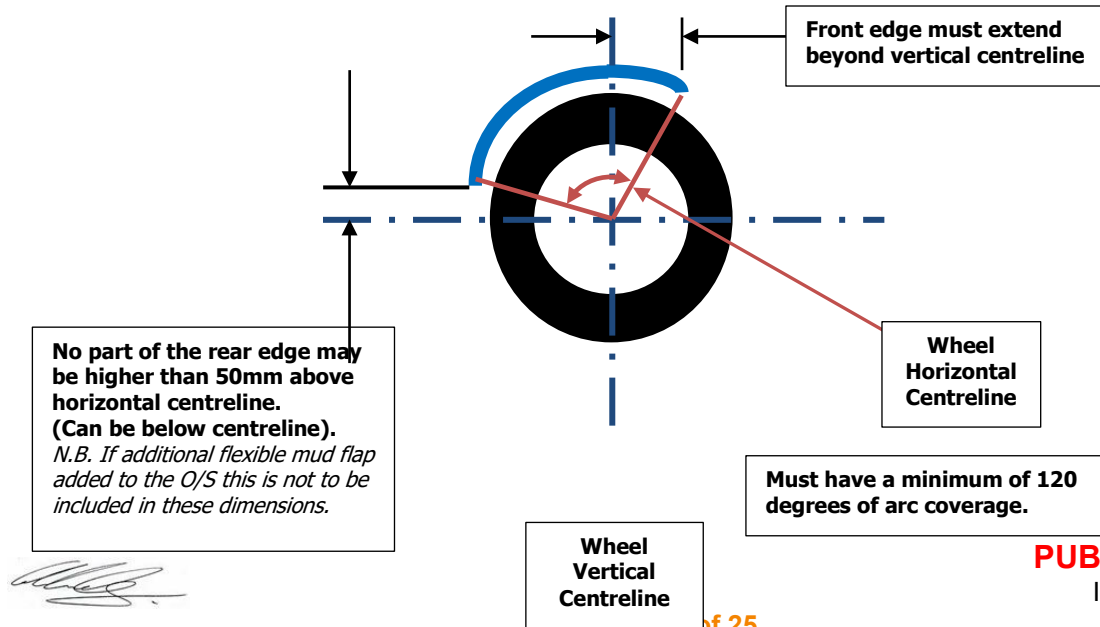
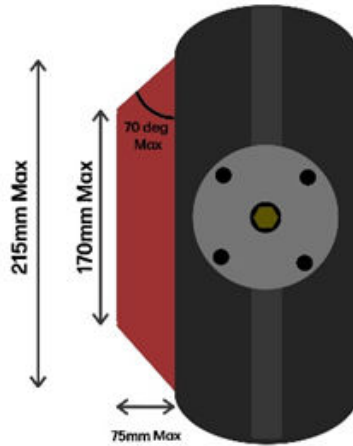

Diagram 8 – Diff Reservoir



Mandatory Parts

- Ma7da Exhaust Manifold – GBS/Kitspares – 01623 860990 Or 750 Motor Club – 01332 814548
- Emerald ECU – 750 Motor Club – 01332 814548
- 100 cell catalytic converter

Optional Parts		Supplier	Contact
Engine/Emerald Wiring Loom	ELC0314	KitSpares	01623 860990
Cone Air Filter	ENG0031	KitSpares	01623 860990
Propshaft	TRA0149	KitSpares	01623 860990
Engine Mount Kit	ENG0091	KitSpares	01623 860990
Gearbox Mount Kit	TRA0036	KitSpares	01623 860990
High Pressure Fuel Pump	FUE0011	KitSpares	01623 860990
High Pressure Fuel Line and Clips Kit	FUE0007	KitSpares	01623 860990
Swirl Pot	FUE0017	KitSpares	01623 860990
Throttle Cable	CAB0006	KitSpares	01623 860990
Alloy Radiator	CST0259	KitSpares	01623 860990
Silencer	EXH0015	KitSpares	01623 860990





Appendix 1: Race with Respect



A socially-minded standard of behaviour is expected from everyone within the motorsport community. By participating in a Motorsport UK event in any capacity you agree to follow the values of the Respect Code: [Motorsportuk.org/racewithrespect](https://motorsportuk.org/racewithrespect), #RaceWithRespect

The Values

- Respect
- Fair play
- Integrity
- Good Manners
- Self-Control

I pledge to #RaceWithRespect and:

- Contribute to a welcoming and friendly environment that ensures the safety and welfare of all participants.
- Always behave with integrity and uphold fairness in the sport; play my part in keeping the sport safety through your actions
- Treat everyone with respect, regardless of their gender, ethnic or social background, language, religious or other beliefs, disability, sexual identity or other status
- Recognise that we all represent the sport and therefore have a duty to be polite and respectful to all staff, officials, fellow competitors, volunteers, as well as fans and supporters
- Respect the rules, regulations and authority of the officials and Motorsport UK
- Any breach of these obligations may result in disciplinary action.